

DRIVE THE CHANGE.



only 2 minutes
very fast

...and many other attachments





-  Servo drive Hyd
-  Power Sensibility
-  Joystick for 1° and 2° Hyd Output
-  analog-digital dashboard



-  3° 4° HR 5° Hydraulic Output
-  Buzzer alarm
-  Horn hazard
-  Parking Brake

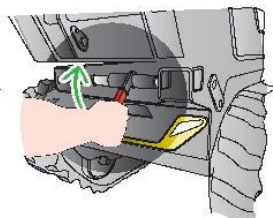

1

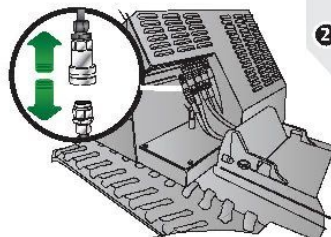

2

only **2** minutes
very fast

MULTIFUNCTION



POWER SENSIBILITY
regulador de potencia



SUPER SILENT ENGINE COVER WITH FAST LOCK
cubierta del motor



ROCKING ROLLERS
Rodillos Oscilantes



SPECIAL HANDLE
manejar especiales



HF HI FLOW
2 X VARIABLE PISTONS PUMPS
bomba de piston var.de



HYD QUICK COUPLER
hyd rápida acoplador



ISOLATOR BATTERY SWITCH
interruptor de la batería



GREASE POINT
punto de engrase



FUEL CAP WITH KEY
tapa de combustible con llave



HEAVY DUTY RUBBER TRACK



DOUBLE CLOSED-CIRCUIT BROADCAST
bomba de piston var.de



QUICK ATTACH
acoplamiento rápido



STANDING PLATFORM WITH AUTO SAFETY LOCK
plataforma de pie con el bloqueo auto de seguridad



HYDRAULIC OIL COOLER
enfriador de aceite hidráulico



STEEL SPROCKET
ruedas de acero



TWIN CARTRIDGE AIR FILTERS
cart. de doble filtro de aire



4 STEEL LIFTING HOOKS
4 ganchos de elevación



AUTO LEVELLING
nivelación auto

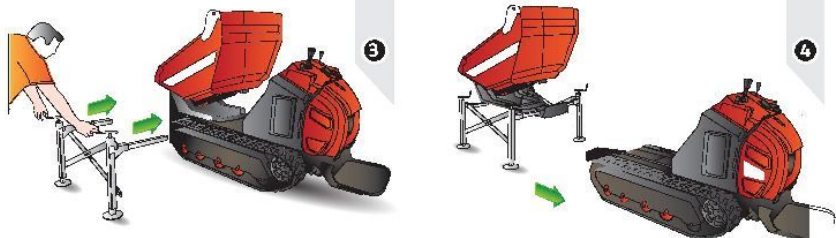

DUMPER SKIP



QUICK ATTACH
ATTACHMENT
ACCESORIOS
CONEXIÓN RÁPIDA

C

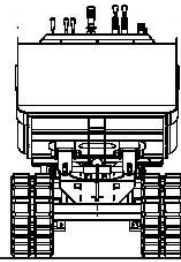

A

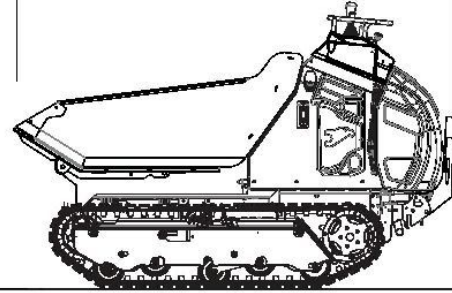

	m ³	n	1500	1600
A	2480	98	•	•
C	900	35.4	•	•

SPECIFICATIONS

	1500	1600
DRY WEIGHT ATTACHMENT (PESO DEL EQUIPO)	150 KG 331 LB	• •
SKIP CAPACITY / CAPACIDAD DEL VOLQUETE	SAE GROSS 0,59 m ³ 0,78 yd ³	• •

SWIVEL DUMPER SKIP +180°

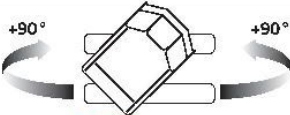

QUICK ATTACH
ATTACHMENT
ACCESORIOS
CONEXIÓN RÁPIDA

C D

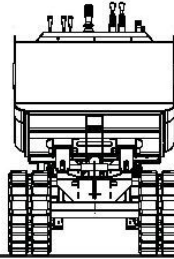

A

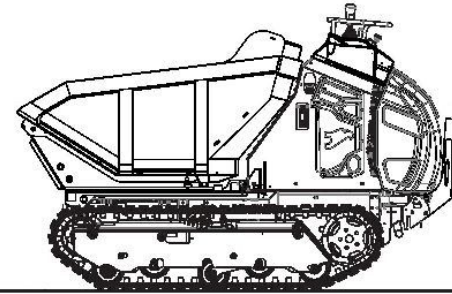

	m ³	n	1500	1600
A	2480	98	•	•
C	917	35.1	•	•
D	868	34.7	•	•

SPECIFICATIONS

	1500	1600
DRY WEIGHT ATTACHMENT (PESO DEL EQUIPO)	285 KG 628 LB	• •
SKIP CAPACITY / CAPACIDAD DEL VOLQUETE	SAE GROSS 0,69 m ³ 0,9 yd ³	• •

HI TIP



QUICK ATTACH
ATTACHMENT
ACCESORIOS
CONEXIÓN RÁPIDA

C

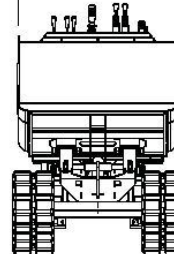

A

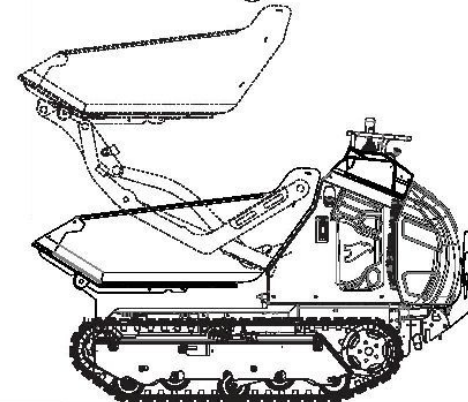

	m ³	n	1500	1600
A	2480	98	•	•
C	900	35.4	•	•

SPECIFICATIONS

	1500	1600
SKIP CAPACITY / CAPACIDAD DEL VOLQUETE	SAE GROSS 0,59 m ³ 0,78 yd ³	• •

MINI LOADER



QUICK ATTACH
ATTACHMENT
ACCESORIOS
CONEXIÓN RÁPIDA

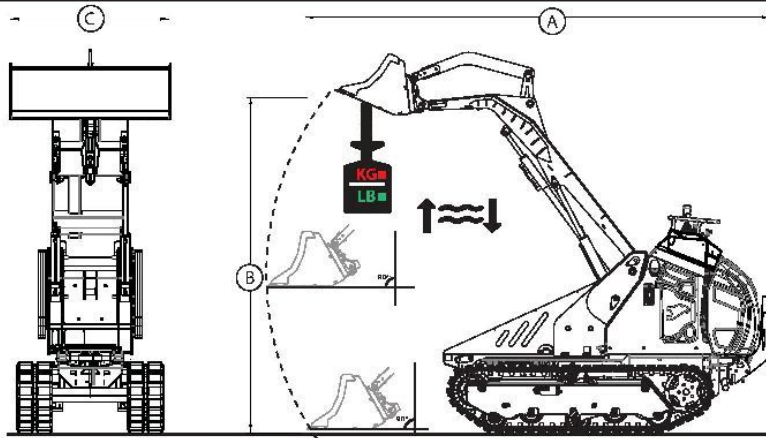

	m	in	1500	1600
A	2850	112	•	•
B	2250	88.6	•	•
C	1050	41.3	•	•

SPECIFICATIONS / ESPECIFICACIONES

	without counterweight	with counterweight (210kg 462lb)
TIPPING LOAD	994 KG 2191 LB	1150 KG 2535 LB
TIPPING CAPACITY SAE 50%	497 KG 1096 LB	575 KG 1268 LB
TIPPING CAPACITY SAE 35%	348 KG 767 LB	403 KG 888 LB
DRY WEIGHT (PESO DEL EQUIPO)	330 KG 728 LB	540 KG 1190 LB

DUMPER SKIP + SELF LOADING



QUICK ATTACH
ATTACHMENT
ACCESORIOS
CONEXIÓN RÁPIDA

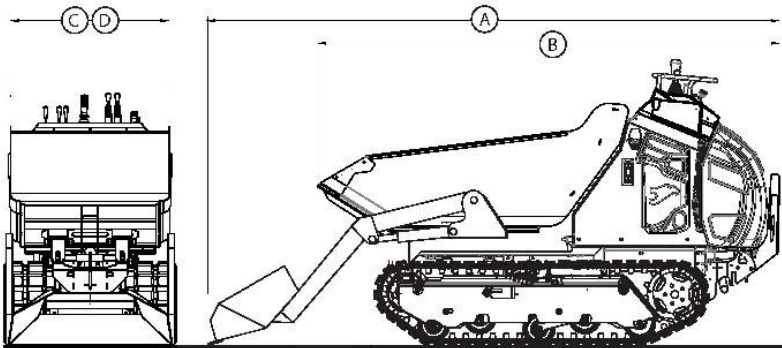

	m	in	1500	1600
A	2990	118	•	•
B	2480	98	•	•
C	974	38.4	•	•
D	945	37.2	•	•

SPECIFICATIONS / ESPECIFICACIONES

SKIP CAPACITY / CAPACIDAD DEL VOLQUETE	SAE GROSS 0,46 m ³ 0,61 yd ³
--	--

HI TIP + SELF LOADING



QUICK ATTACH
ATTACHMENT
ACCESORIOS
CONEXIÓN RÁPIDA

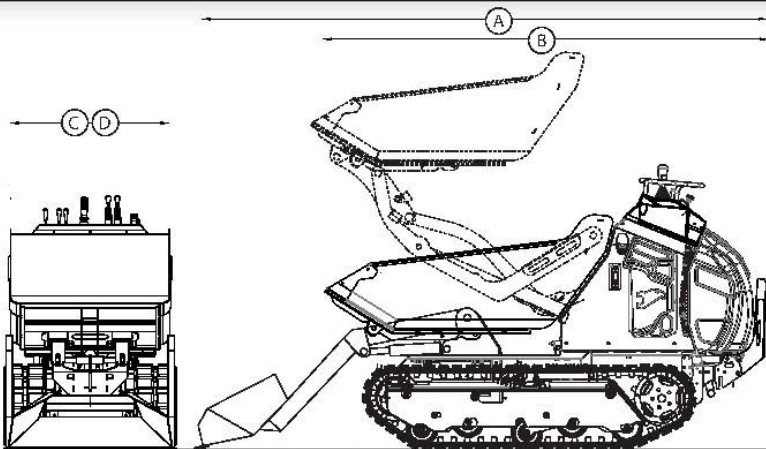

	m	in	1500	1600
A	2990	118	•	•
B	2480	98	•	•
C	924	36.4	•	•
D	945	37.2	•	•

SPECIFICATIONS / ESPECIFICACIONES

SKIP CAPACITY / CAPACIDAD DEL VOLQUETE	SAE GROSS 0,46 m ³ 0,61 yd ³
--	--

SWIVEL CONCRETE MIXER



QUICK ATTACH
ATTACHMENT
ACCESORIOS
CONEXIÓN RÁPIDA

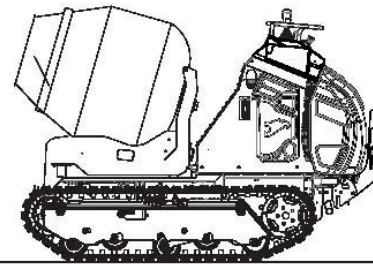
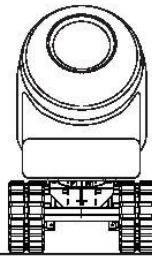
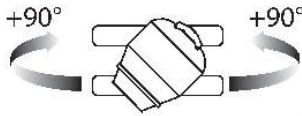

SPECIFICATIONS

OPERATIVE WEIGHT (CAPACIDAD OPERATIVA)

GROSS 0,6 m³ 0,78 yd³

NET 0,4 m³ 0,52 yd³

SWIVEL CONCRETE MIXER+ SELF LOADING



QUICK ATTACH
ATTACHMENT
ACCESORIOS
CONEXIÓN RÁPIDA

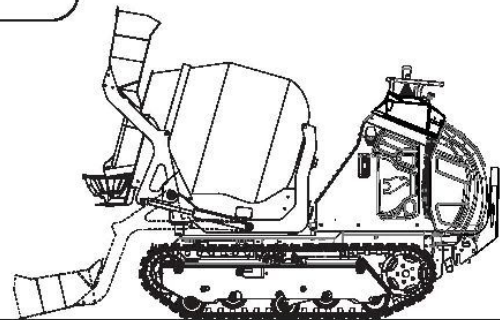
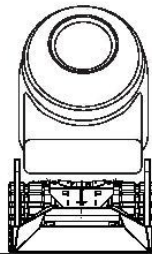
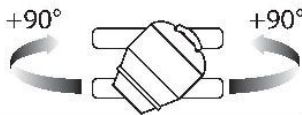

SPECIFICATIONS

OPERATIVE CAPACITY (CAPACIDAD OPERATIVA)

GROSS 0,6 m³ 0,78 yd³

NET 0,4 m³ 0,52 yd³



attachments / accesorios

FORK / UÑAS

specifications / especificaciones

Load capacity / Capacidad de carga **400 kg (891 lb)**



BLADE / PALA



WEED WACKER / CORTA MALEZA

specifications / especificaciones

Dimensions / Dimensiones **L800 800mm (31.5 in)**

Dimensions / Dimensiones **L1000 1000 mm (39.4 in)**



BRUSH / CEPILLO



TRENCHER / ABRE ZANJAS



HYD. SNOW BLOW. / QUITANIEVES HID.

specifications / especificaciones

Dimensions / Dimensiones **L1000 1000 mm (39.4 in)**

Dimensions / Dimensiones **L1300 1300 mm (51.2 in)**



HYD. HAMMER / MARTILLO HID.

specifications / especificaciones

Operative weight / Peso operativo **64 kg (141 lb)**



HYD. AUGER / BARRENA HID.



UNIV. QUICK ATTACH / PLACA UNIVERSAL



EXCAVATOR / EXCAVADORA



4 IN 1 BUCKETS / CAZOS 4 EN 1



DEMOLITIONS SHEARS / PINZA DEMOL



SPECIFICATIONS	1500 - 1600		
	METRIC	U.S.	version
ENGINE / MOTOR			
Diesel	Kubota D1105 26hp TIER 4		
TRANSMISSION / TRANSMISIÓN			
Type / Tipo	Hydrostatic / Hidraulica		
Hydraulic pump / Bomba Hidráulica	2 variable pistons pumps 93 lt/min 365bar (24.6 gpm 5234 psi) Bombas de 2 pistones variables 93 lt / min 365bar (24,6 gpm 5234 psi)		
TRACKS / SISTEMA DE RODAMIENTO			
Stand. tracks width/Ancho de la oruga stand.	230 mm	(9.1 in)	
Rocking Rollers / Rodillos Oscilantes	Yes / Si		
Rollers / Rodillos	n° 5		
HYDRAULIC SYSTEM / SISTEMA HIDRÁULICO			
Hydraulic pump / Bomba Hidráulica	Gear pump / Equipo		
Flow std. / Flujo Std. (Versione: Spec 1 / Spec 2)	1x30.5 l/min 200 bar	(1x8.1 gpm 2900 psi)	
HYDRAULIC SYSTEM / SISTEMA HIDRÁULICO			
Hydraulic pump / Bomba Hidráulica	Variable pistons pumps / Bombas de pistones variable		
Hi-flow / Flujo Hi-Flow (Versione: Spec 3)	1x52 l/min 280 bar	(1x13.7 gpm 4061 psi)	
ADDITIONAL OUTPUT / CONEXIÓN ADICIONAL			
Additional HYD output / conexión HYD adicional	n° 2		spec-1
Additional HYD output / conexión HYD adicional	n° 5		spec-2
Additional HYD output / conexión HYD adicional	n° 5		spec-3
PERFORMANCE AND DIMENSIONS / RENDIMIENTO Y DIMENSIONES			
Max. Travel Speed / Veloc. Max	(7.6 Km/h)	(4.7 mph)	
Operative weight / Capacidad operativa	1500 kg	(3307 LB)	1500
	1600 kg	(3527 LB)	1600
Weight / Peso	899 kg	(1982 LB)	1500
	919 kg	(2026 LB)	1600
Parking brake / freno de estacionamiento	Yes / Si		
Power sensibility / sensibilidad de energía	Yes / Si		

Dimensions and weights without attachments / Las dimensiones y pesos sin accesorios

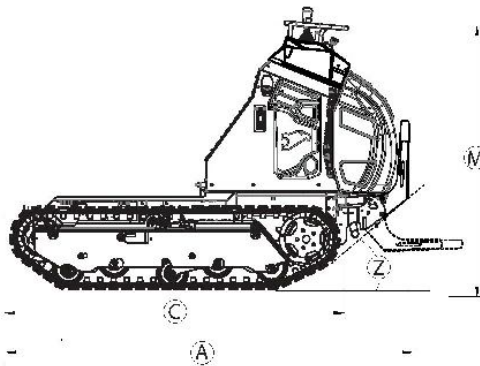
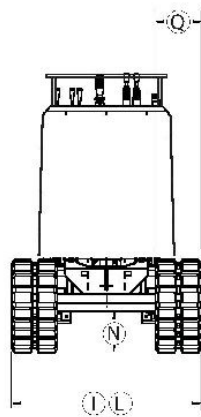

DIMENSIONS / DIMENSIONES				
	mm	in	1500	1600
A	2160	85.4	•	•
C	1770	69.7	•	•
I	895	35.2	•	•
L	945	37.2	•	•
M	1370	54	•	•
N	203	8	•	•
Q	230	9.1	•	•
Z	42°		•	•

CORMIDI S.r.l. Via Fonte, 342
84069 Roccadaspide (SA) Italy
Tel. +39 0828 943688 - Fax +39 0828 943963
info@cormidi.com
www.cormidi.com



ALEXANDROS SPATHARAS COMPANY
CRANES - MACHINERY-SPARE PARTS
41, Iasonidou Str.
GR-56334 Thessaloniki, GREECE
N. Kordelio - Eleftheria.
Tel : +30 2310 709155
Fax :+30 2310 709989
www.spatharas.eu

all information in this brochure can change without notice / toda la información en este folleto puede cambiar sin previo aviso

globe image: ianola mark Ltd